

Data sheet | Item number: 750-823

Controller EtherNet/IP; 4th generation; 2 x ETHERNET; ECO

www.wago.com/750-823

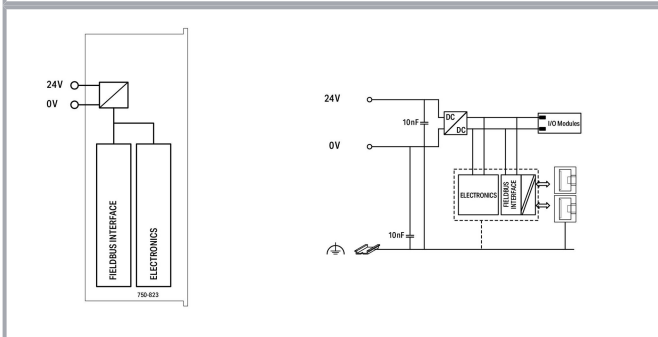
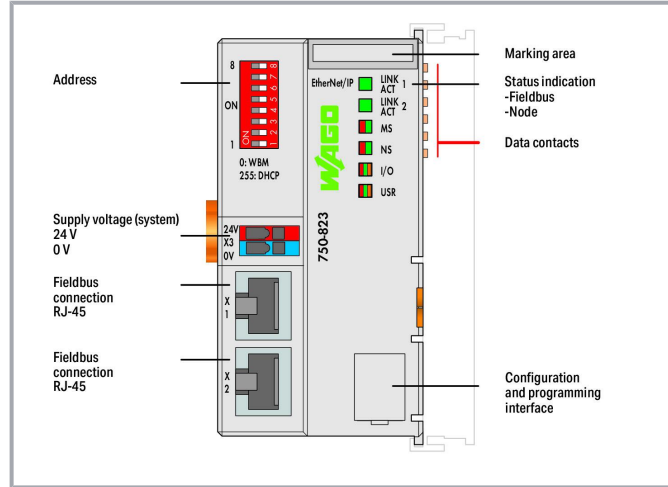
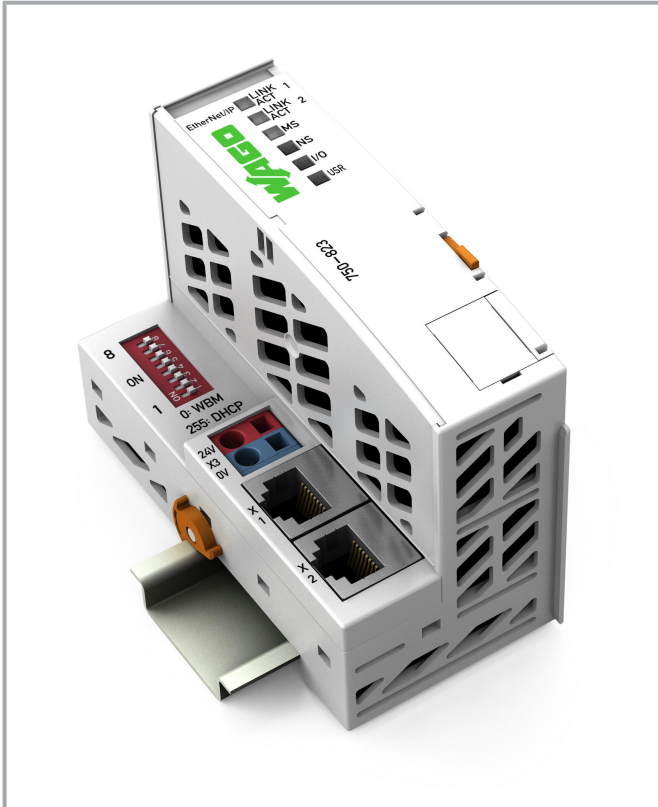

Item description

This controller can be used as a programmable controller within EtherNet/IP networks in conjunction with the WAGO I/O System. The controller detects all connected I/O modules and creates a local process image. This process image may include a mixed arrangement of analog (word-by-word data transfer) and digital (bit-by-bit data transfer) modules. Two ETHERNET interfaces and an integrated switch allow the fieldbus to be wired in a line topology, eliminating the need for additional network

Subject to changes. Please also observe the further product documentation!

WAGO Corporation
Germantown, WI 53022
Phone: 1-800-DIN-RAIL (346-7245) | Fax: (262) 255-6222
Email: info.us@wago.com | Web: www.wago.us

Do you have any questions about our products?
We are always happy to take your call at (262) 255-6222 or 1 800-DIN-RAIL.



devices, such as switches or hubs. Both interfaces support autonegotiation and Auto-MDI(X).

The DIP switch configures the last byte of the IP address and may be used for IP address assignment.

The controller is designed for fieldbus communication in EtherNet/IP networks. It also supports a wide variety of standard ETHERNET protocols (e.g., HTTP(S), BootP, DHCP, DNS, SNTp, (S)FTP, SNMP).

An integrated Webserver provides user configuration options, while displaying the controller's status information.

The IEC 61131-3 programmable controller is multitasking-capable.

Data

Technical data

Communication	EtherNet/IP™
ETHERNET protocols	HTTP(S) BootP DHCP DNS SNTp FTP(S) SNMP
Visualization	Web Visu
CPU	32 bits
Programming languages per IEC 61131-3	Instruction List (IL) Ladder Diagram (LD) Function Block Diagram (FBD), Continuous Function Chart (CFC) Structured Text (ST) Sequential Function Chart (SFC)
Programming environment	WAGO-I/O-PRO V2.3 (based on CODESYS V2.3)
Configuration options	WAGO-I/O-CHECK Web-Based Management CODESYS Library
Baud rate (communication/fieldbus 1)	10/100 Mbit/s
Baud rate	10/100 Mbit/s
Transmission medium (communication/fieldbus)	Twisted Pair S-UTP; 100 Ω; Cat. 5; 100 m maximum cable length
Transmission performance	Class D per EN 50173
Program memory	2 MB
Data memory	2 MB
Non-volatile software memory	32 Kbytes
Number of modules per node (max.)	250
Number of modules without a bus extension (max.)	64
Input and output (fieldbus) process image (max.)	1020 Worte/1020 Worte
Indicators	LED (LINK/ACT) green: Network connection via ports 1 ... 2; LED (MS, NS) red/green: Status of node, network; LED (I/O, USR) red /green/orange: Local data bus status, status programmable by user

Subject to changes. Please also observe the further product documentation!

WAGO Corporation
Germantown, WI 53022
Phone: 1-800-DIN-RAIL (346-7245) | Fax: (262) 255-6222
Email: info.us@wago.com | Web: www.wago.us

Do you have any questions about our products?
We are always happy to take your call at (262) 255-6222 or 1 800-DIN-RAIL.



Supply voltage (system)	24 VDC (-25 ... +30 %); via pluggable connector
Input current (typ.) at nominal load (24 V)	300 mA
Power supply efficiency (typ.) at nominal load (24 V)	90 %
Power consumption (5 V system supply)	390 mA
Total current (system supply)	700 mA
Isolation	500 V system/field

Connection data

Connection technology: communication/fieldbus	EtherNet/IP™; 2 x RJ-45
Connection technology: system supply	2 x CAGE CLAMP®
Connection type (1)	System supply
Solid conductor	0.08 ... 2.5 mm ² / 28 ... 14 AWG
Fine-stranded conductor	0.08 ... 2.5 mm ² / 28 ... 14 AWG
Strip length	8 ... 9 mm / 0.31 ... 0.35 inch
Connection technology: device configuration	1 x Male connector; 4-pole

Physical data

Width	49.5 mm / 1.949 inch
Height	96.8 mm / 3.811 inch
Depth	71.9 mm / 2.831 inch
Depth from upper edge of DIN-rail	64.7 mm / 2.547 inch

Mechanical data

Weight	105.3 g
Housing material	Polycarbonate; Polyamide 6.6

Environmental requirements

Surrounding air temperature (operation)	0 ... 55 °C
Surrounding air temperature (storage)	-25 ... 85 °C
Protection type	IP20
Pollution degree (5)	2 per IEC 61131-2
Operating altitude	without temperature derating: 0 ... 2000 m; with temperature derating: 2000 ... 5000 m (0.5 K/100 m); 5000 m (max.)
Relative humidity (without condensation)	95 %
Mounting position	any
Mounting type	DIN-35 rail

Subject to changes. Please also observe the further product documentation!

WAGO Corporation
 Germantown, WI 53022
 Phone: 1-800-DIN-RAIL (346-7245) | Fax: (262) 255-6222
 Email: info.us@wago.com | Web: www.wago.us

Do you have any questions about our products?
 We are always happy to take your call at (262) 255-6222 or 1 800-DIN-RAIL.





Vibration resistance	4g per IEC 60068-2-6
Shock resistance	15g per IEC 60068-2-27
EMC immunity to interference	per EN 61000-6-2, marine applications
EMC emission of interference	per EN 61000-6-3, marine applications
Exposure to pollutants	Per IEC 60068-2-42 and IEC 60068-2-43
Fire load	1.368 MJ
Permissible pollutant concentration H ₂ S at a relative humidity < 75%	10 ppm
Permissible pollutant concentration SO ₂ at a relative humidity < 75%	25 ppm

Commercial data

Packaging type	BOX
Country of origin	DE
GTIN	4055143889094
Customs tariff number	8537109160

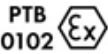
Approvals / Certificates

Ex-Approvals

Logo	Approval	Additional Approval Text	Certificate name
	ATEX TUEV Nord Cert GmbH	EN 60079	TUEV_14_ATEX_148929_X
 Ex nA IIC T4 Gc	CCCEX CQST/CNEX	CNCA-C23-01	2020312310000213
	IECEX TUEV Nord Cert GmbH	IEC 60079	IECEX_TUN_14.0035_X
	UL Underwriters Laboratories Inc. (HAZARDOUS LOCATIONS)	UL 121201	E198726 Sec.1

Country specific Approvals





Logo	Approval	Additional Approval Text	Certificate name
	KC National Radio Research Agency	Article 58-2, Clause 3	MSIP-REM-W43-

Subject to changes. Please also observe the further product documentation!

WAGO Corporation
Germantown, WI 53022
Phone: 1-800-DIN-RAIL (346-7245) | Fax: (262) 255-6222
Email: info.us@wago.com | Web: www.wago.us

Do you have any questions about our products?
We are always happy to take your call at (262) 255-6222 or 1 800-DIN-RAIL.

Ship Approvals

Logo	Approval	Additional Approval Text	Certificate name
	ABS American Bureau of Shipping	-	19- HG1821926
	DNV GL Det Norske Veritas, Germanischer Lloyd	-	TAA0000194
	LR Lloyds Register	-	02/20026 (E6)
	RINA RINA Germany GmbH	-	ELE066419XG

UL-Approvals

Logo	Approval	Additional Approval Text	Certificate name
	UL Underwriters Laboratories Inc. (ORDINARY LOCATIONS)	UL 61010-2-201	E175199 Sec11

Optional accessories

Marking accessories







✓	Item no.: 2009-145 Mini-WSB Inline; for Smart Printer; 1700 pieces on roll; stretchable 5 - 5.2 mm; plain; snap-on type; white	www.wago.com/2009-145
✓	Item no.: 2009-145/000-002 Mini-WSB Inline; for Smart Printer; 1700 pieces on roll; stretchable 5 - 5.2 mm; plain; snap-on type; yellow	www.wago.com/2009-145/000-002
✓	Item no.: 2009-145/000-005 Mini-WSB Inline; for Smart Printer; 1700 pieces on roll; stretchable 5 - 5.2 mm; plain; snap-on type; red	www.wago.com/2009-145/000-005

Subject to changes. Please also observe the further product documentation!

WAGO Corporation
Germantown, WI 53022
Phone: 1-800-DIN-RAIL (346-7245) | Fax: (262) 255-6222
Email: info.us@wago.com | Web: www.wago.us

Do you have any questions about our products?
We are always happy to take your call at (262) 255-6222 or 1 800-DIN-RAIL.



/	<p>Item no.: 2009-145/000-006 Mini-WSB Inline; for Smart Printer; 1700 pieces on roll; stretchable 5 - 5.2 mm; plain; snap-on type; blue</p>	<p>www.wago.com/2009-145/000-006</p>
/	<p>Item no.: 2009-145/000-007 Mini-WSB Inline; for Smart Printer; 1700 pieces on roll; stretchable 5 - 5.2 mm; plain; snap-on type; gray</p>	<p>www.wago.com/2009-145/000-007</p>
/	<p>Item no.: 2009-145/000-012 Mini-WSB Inline; for Smart Printer; 1700 pieces on roll; stretchable 5 - 5.2 mm; plain; snap-on type; orange</p>	<p>www.wago.com/2009-145/000-012</p>
/	<p>Item no.: 2009-145/000-023 Mini-WSB Inline; for Smart Printer; 1700 pieces on roll; stretchable 5 - 5.2 mm; plain; snap-on type; green</p>	<p>www.wago.com/2009-145/000-023</p>
/	<p>Item no.: 2009-145/000-024 Mini-WSB Inline; for Smart Printer; 1700 pieces on roll; stretchable 5 - 5.2 mm; plain; snap-on type; violet</p>	<p>www.wago.com/2009-145/000-024</p>
/	<p>Item no.: 248-501 Mini-WSB marking card; as card; not stretchable; plain; snap-on type; white</p>	<p>www.wago.com/248-501</p>
	<p>Item no.: 248-501/000-002 Mini-WSB marking card; as card; not stretchable; plain; snap-on type; yellow</p>	<p>www.wago.com/248-501/000-002</p>
	<p>Item no.: 248-501/000-005 Mini-WSB marking card; as card; not stretchable; plain; snap-on type; red</p>	<p>www.wago.com/248-501/000-005</p>
	<p>Item no.: 248-501/000-006 Mini-WSB marking card; as card; not stretchable; plain; snap-on type; blue</p>	<p>www.wago.com/248-501/000-006</p>
	<p>Item no.: 248-501/000-007 Mini-WSB marking card; as card; not stretchable; plain; snap-on type; gray</p>	<p>www.wago.com/248-501/000-007</p>
	<p>Item no.: 248-501/000-012 Mini-WSB marking card; as card; not stretchable; plain; snap-on type; orange</p>	<p>www.wago.com/248-501/000-012</p>
	<p>Item no.: 248-501/000-017 Mini-WSB marking card; as card; not stretchable; plain; snap-on type; light green</p>	<p>www.wago.com/248-501/000-017</p>
	<p>Item no.: 248-501/000-023 Mini-WSB marking card; as card; not stretchable; plain; snap-on type; green</p>	<p>www.wago.com/248-501/000-023</p>

Subject to changes. Please also observe the further product documentation!

**Item no.: 248-501/000-024**

Mini-WSB marking card; as card; not stretchable; plain; snap-on type; violet

www.wago.com/248-501/000-024**System housing****Item no.: 850-804**

IP65 enclosure; Stainless steel; WxHxD (400x123x200 mm); 4 x M20, 16 x M16, 28 x M12 cable grip

www.wago.com/850-804**Item no.: 850-804/000-001**

IP65 enclosure; Stainless steel; WxHxD (400x123x200 mm); 2 x M20, 13 x M16, 32 x M12 cable grip

www.wago.com/850-804/000-001**Item no.: 850-805**

IP65 enclosure; Stainless steel; WxHxD (600x123x200 mm); 4 x M20, 19 x M16, 67 x M12 cable grip

www.wago.com/850-805**Item no.: 850-814/002-000**

IP65 enclosure; Sheet steel (RAL 7035); WxHxD (200x120x200 mm); without flange plate

www.wago.com/850-814/002-000**Item no.: 850-815/002-000**

IP65 enclosure; Sheet steel (RAL 7035); WxHxD (300x120x200 mm); without flange plate

www.wago.com/850-815/002-000**Item no.: 850-816/002-000**

IP65 enclosure; Sheet steel (RAL 7035); WxHxD (400x120x200 mm); without flange plate

www.wago.com/850-816/002-000**Item no.: 850-817/002-000**

IP65 enclosure; Sheet steel (RAL 7035); WxHxD (600x120x200 mm); without flange plate

www.wago.com/850-817/002-000**Item no.: 850-825**

IP65 enclosure; Aluminium (RAL 7032); WxHxD (160x100x160 mm); 9 x M12, 4 x M20

www.wago.com/850-825**Item no.: 850-826**

IP65 enclosure; Aluminium (RAL 7032); WxHxD (240x100x160 mm); 4 x M20, 4 x M16, 14 x M12 cable grip

www.wago.com/850-826**Item no.: 850-826/002-000**

IP65 enclosure; Aluminium (RAL 7035); WxHxD (240x100x160 mm); 4 x M20, 4 x M16, 14 x M12 cable grip

www.wago.com/850-826/002-000**Item no.: 850-827**

IP65 enclosure; Aluminium (RAL 7032); WxHxD (320x100x160 mm); 4 x M20, 8 x M16, 17 x M12 cable grip

www.wago.com/850-827**Item no.: 850-827/002-000**





IP65 enclosure; Aluminium (RAL 7035); WxHxD (320x100x160 mm); 4 x M20, 8 x M16, 17 x M12 cable grip

www.wago.com/850-827/002-000**Item no.: 850-828**

IP65 enclosure; Aluminium (RAL 7032); WxHxD (480x100x160 mm); 4 x M20, 10 x M16, 35 x M12 cable grip

www.wago.com/850-828**Item no.: 850-828/002-000**

Subject to changes. Please also observe the further product documentation!

	IP65 enclosure; Aluminium (RAL 7035); WxHxD (480x100x160 mm); 4 x M20, 10 x M16, 35 x M12 cable grip	www.wago.com/850-828/002-000
	Item no.: 850-834 IP65 enclosure; Polyester (RAL 7032); WxHxD (164x100x164 mm); 9 x M12, 4 x M20	www.wago.com/850-834
	Item no.: 850-835 IP65 enclosure; Polyester (RAL 7032); WxHxD (244x100x164 mm); 4 x M20, 4 x M16, 14 x M12 cable grip	www.wago.com/850-835
	Item no.: 850-836 IP65 enclosure; Polyester (RAL 7032); WxHxD (324x100x164 mm); 4 x M20, 8 x M16, 17 x M12 cable grip	www.wago.com/850-836

Carrier rail

	Item no.: 210-112 Steel carrier rail; 35 x 7.5 mm; 1 mm thick; 2 m long; slotted; according to EN 60715; "Hole width 25 mm; silver-colored	www.wago.com/210-112
	Item no.: 210-113 Steel carrier rail; 35 x 7.5 mm; 1 mm thick; 2 m long; unslotted; according to EN 60715; silver-colored	www.wago.com/210-113
	Item no.: 210-114 Steel carrier rail; 35 x 15 mm; 1.5 mm thick; 2 m long; unslotted; similar to EN 60715; silver-colored	www.wago.com/210-114
	Item no.: 210-115 Steel carrier rail; 35 x 7.5 mm; 1 mm thick; 2 m long; slotted; according to EN 60715; "Hole width 18 mm; silver-colored	www.wago.com/210-115
	Item no.: 210-118 Steel carrier rail; 35 x 15 mm; 2.3 mm thick; 2 m long; unslotted; according to EN 60715; silver-colored	www.wago.com/210-118
	Item no.: 210-196 Aluminum carrier rail; 35 x 8.2 mm; 1.6 mm thick; 2 m long; unslotted; similar to EN 60715; silver-colored	www.wago.com/210-196
	Item no.: 210-197 Steel carrier rail; 35 x 15 mm; 1.5 mm thick; 2 m long; slotted; similar to EN 60715; silver-colored	www.wago.com/210-197
	Item no.: 210-198 Copper carrier rail; 35 x 15 mm; 2.3 mm thick; 2 m long; unslotted; according to EN 60715; copper-colored	www.wago.com/210-198
	Item no.: 210-504 Steel carrier rail; 35 x 7.5 mm; 1 mm thick; 2 m long; slotted; galvanized; according to EN 60715; silver-colored	www.wago.com/210-504
	Item no.: 210-505 Steel carrier rail; 35 x 7.5 mm; 1 mm thick; 2 m long; unslotted; galvanized; according to EN 60715; silver-colored	www.wago.com/210-505
	Item no.: 210-506 Steel carrier rail; 35 x 15 mm; 1.5 mm thick; 2 m long; unslotted; galvanized; similar to EN 60715; silver-colored	www.wago.com/210-506
	Item no.: 210-508 Steel carrier rail; 35 x 15 mm; 1.5 mm thick; 2 m long; slotted; galvanized; similar to EN 60715; silver-colored	www.wago.com/210-508















Software

Subject to changes. Please also observe the further product documentation!

WAGO Corporation
 Germantown, WI 53022
 Phone: 1-800-DIN-RAIL (346-7245) | Fax: (262) 255-6222
 Email: info.us@wago.com | Web: www.wago.us

Do you have any questions about our products?
 We are always happy to take your call at (262) 255-6222 or 1 800-DIN-RAIL.



	Item no.: 759-333 WAGO-I/O-PRO	www.wago.com/759-333
	Item no.: 759-333/000-923 WAGO-I/O-PRO; USB-Set	www.wago.com/759-333/000-923
	Item no.: 759-911 WAGO-I/O-PRO; CD	www.wago.com/759-911
Cables and pluggable connectors		
	Item no.: 750-975 RJ-45 connector; IP20; ETHERNET 10/100 Mbit/s	www.wago.com/750-975
	Item no.: 750-977/000-011 Connector ETHERNET; RJ-45; Cat. 6A; straight; Code T568A; AWG 22	www.wago.com/750-977/000-011
	Item no.: 750-977/000-012 Connector ETHERNET; RJ-45; Cat. 6A; straight; Code T568B; AWG 22	www.wago.com/750-977/000-012
	Item no.: 750-977/000-021 Connector ETHERNET; RJ-45; Cat. 6A; straight; Code T568A; AWG 24	www.wago.com/750-977/000-021
	Item no.: 750-977/000-022 Connector ETHERNET; RJ-45; Cat. 6A; straight; Code T568B; AWG 24	www.wago.com/750-977/000-022
	Item no.: 750-978/000-011 Connector ETHERNET; RJ-45; Cat. 6A; straight; Code T568A; AWG 22; Strain relief	www.wago.com/750-978/000-011
	Item no.: 750-978/000-012 Connector ETHERNET; RJ-45; Cat. 6A; straight; Code T568B; AWG 22; Strain relief	www.wago.com/750-978/000-012
	Item no.: 750-978/000-021 Connector ETHERNET; RJ-45; Cat. 6A; straight; Code T568A; AWG 24; Strain relief	www.wago.com/750-978/000-021
	Item no.: 750-978/000-022 Connector ETHERNET; RJ-45; Cat. 6A; straight; Code T568B; AWG 24; Strain relief	www.wago.com/750-978/000-022
	Item no.: 750-979/000-011 Connector ETHERNET; RJ-45; Cat. 6A; angled; Code T568A; AWG 22; Strain relief	www.wago.com/750-979/000-011
	Item no.: 750-979/000-012 Connector ETHERNET; RJ-45; Cat. 6A; angled; Code T568B; AWG 22; Strain relief	www.wago.com/750-979/000-012

Subject to changes. Please also observe the further product documentation!

	Item no.: 750-979/000-021 Connector ETHERNET; RJ-45; Cat. 6A; angled; Code T568A; AWG 24; Strain relief	www.wago.com/750-979/000-021
--	---	--

	Item no.: 750-979/000-022 Connector ETHERNET; RJ-45; Cat. 6A; angled; Code T568B; AWG 24; Strain relief	www.wago.com/750-979/000-022
--	---	--

Shield termination

	Item no.: 790-108 Shield clamping saddle; 11 mm wide; 0-8 mm diameter conductors	www.wago.com/790-108
--	--	--

	Item no.: 790-116 Shield clamping saddle; 19 mm wide; 7-16 mm diameter conductors	www.wago.com/790-116
--	---	--

	Item no.: 790-124 Shield clamping saddle; 27 mm wide; 6-24 mm diameter conductors	www.wago.com/790-124
--	---	--

	Item no.: 790-140 Shield clamping saddle; 43 mm wide; 22-40 mm diameter conductors	www.wago.com/790-140
--	--	--

	Item no.: 790-208 Shield clamping saddle; 12.4 mm wide; 3-8 mm diameter conductors	www.wago.com/790-208
--	--	--

	Item no.: 790-216 Shield clamping saddle; 21.8 mm wide; 6-16 mm diameter conductors	www.wago.com/790-216
--	---	--

	Item no.: 790-220 Shield clamping saddle; 30 mm wide; 6-20 mm diameter	www.wago.com/790-220
--	--	--

General accessories

	Item no.: 750-921 Bluetooth® Adapter	www.wago.com/750-921
--	--	--

	Item no.: 750-923 Configuration cable; USB connector; Length: 2.5 m	www.wago.com/750-923
--	---	--

	Item no.: 750-923/000-001 Configuration cable; USB connector; Length: 5 m	www.wago.com/750-923/000-001
--	---	--

Downloads

Documentation

Manual

Controller EtherNet/IP; G4; 2ETH; ECO	V 1.0.3 Jan 18, 2021	pdf 5.3 MB	Download
Controller EtherNet/IP; Generation 4; 2 x ETHERNET; ECO			
System Manual WAGO I/O System 750 / 753	V 3.0.2	pdf	Download

Subject to changes. Please also observe the further product documentation!



Decentralized Automation Technology	Apr 27, 2021	6.6 MB	
System Manual Series 750/753		URL	Download
Bid Text			
750-823 docx - Datei	May 22, 2019	docx 21.7 kB	Download
750-823 X81 - Datei	May 22, 2019	xml 8.2 kB	Download
System Description			
750 Controller, General Product Information		pdf 621.9 kB	Download
Use in Hazardous Environments Term definition, marking and installation regulations	V 1.0.0	pdf 1.0 MB	Download
Overview on WAGO-I/O-SYSTEM 750 approvals		pdf 780.2 kB	Download
Additional Information			
Disposal; Electrical and electronic equipment, Packaging	V 1.0.0	pdf 265.8 kB	Download
Runtime Software			
Firmware			
Firmware: 750-823 Controller EtherNet/IP; 4th generation; 2 x ETHERNET; ECO	07 Sep 16, 2020	zip 4.2 MB	Download
CAD files			
CAD data			
2D/3D Models 750-823		URL	Download
CAE data			
ZUKEN Portal 750-823		URL	Download

Subject to changes. Please also observe the further product documentation!



Device Files

Device Description File

750-919; EDS file for Ethernet/IP / 750-363, 750-366, 750-823, 750-893	1.3 Oct 2, 2020	zip 14.4 kB	Download
--	--------------------	----------------	----------

Environmental Product Compliance

Compliance Search

Environmental Product Compliance 750-823 Controller EtherNet/IP; 4th generation; 2 x ETHERNET; ECO	URL	Download
---	-----	----------

Installation Notes

Product family

PLC Controllers

[Show all products from the family](#)

Subject to changes. Please also observe the further product documentation!

WAGO Corporation
Germantown, WI 53022
Phone: 1-800-DIN-RAIL (346-7245) | Fax: (262) 255-6222
Email: info.us@wago.com | Web: www.wago.us

Do you have any questions about our products?
We are always happy to take your call at (262) 255-6222 or 1 800-DIN-RAIL.